

9 VELUX®

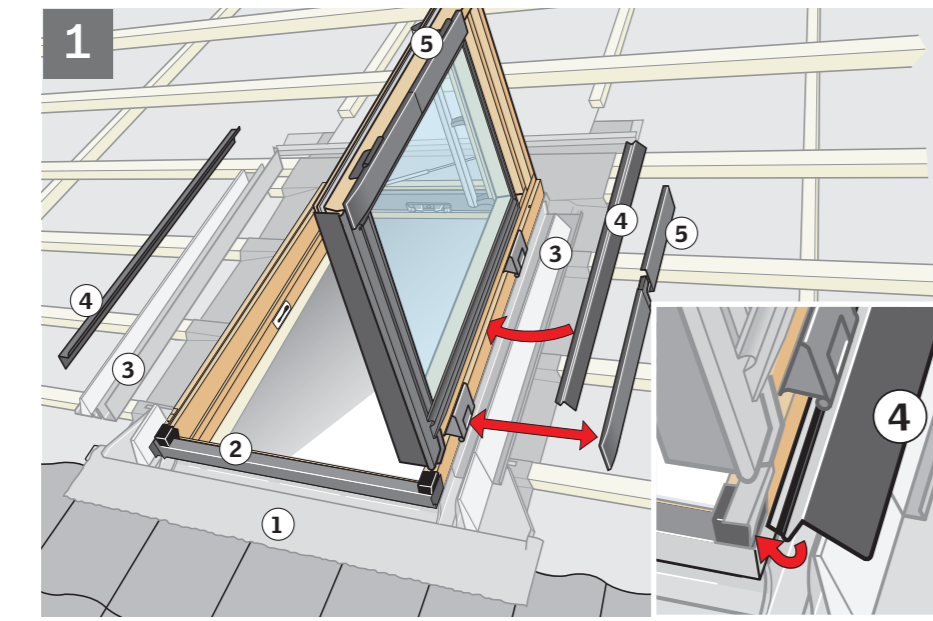

10 VELUX®

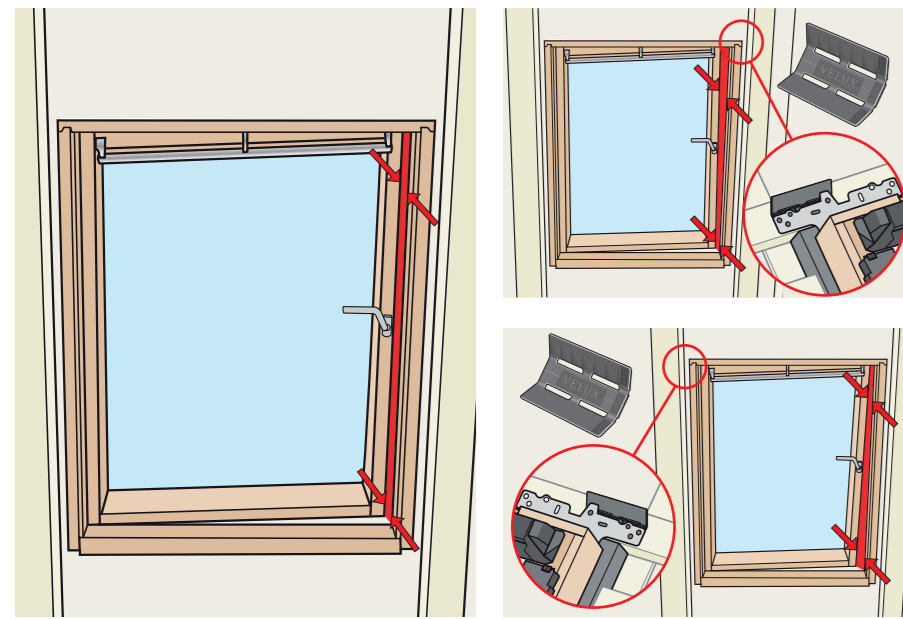
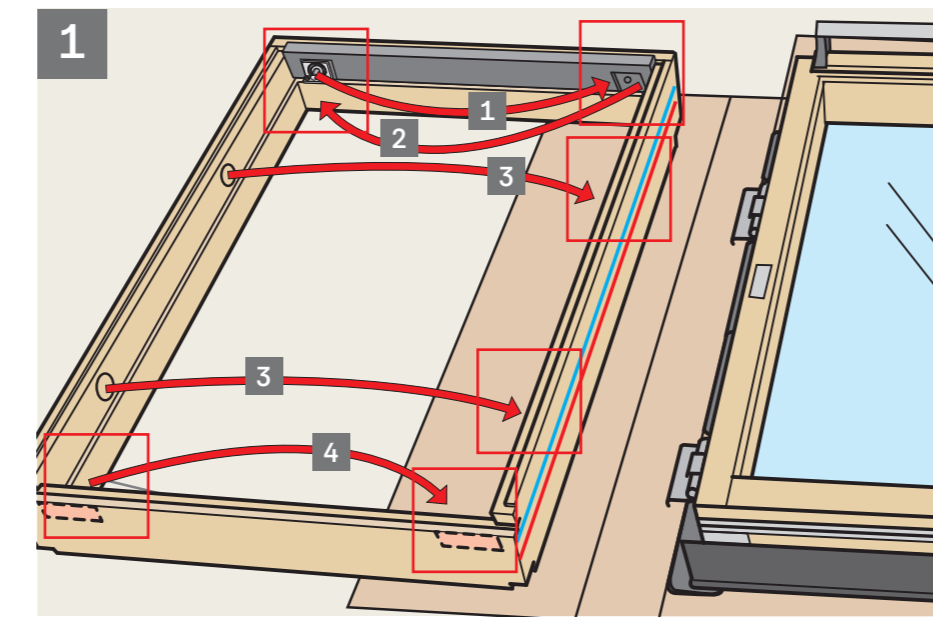
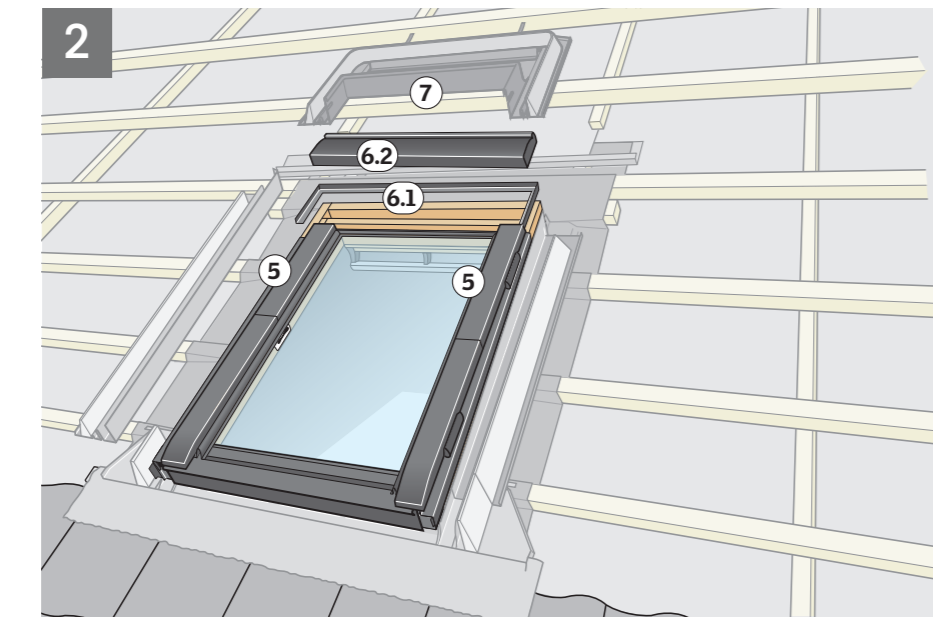

11 VELUX®

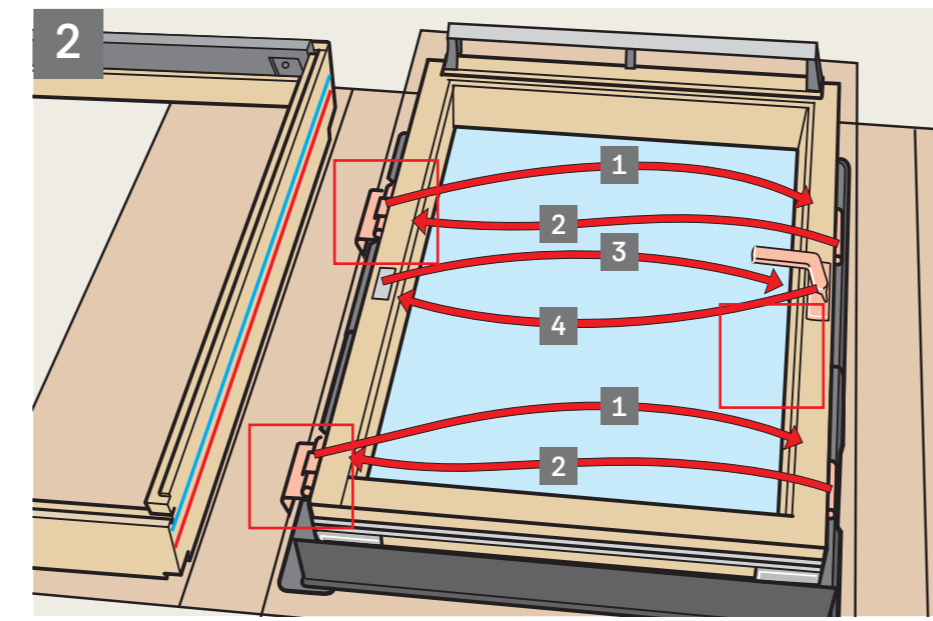
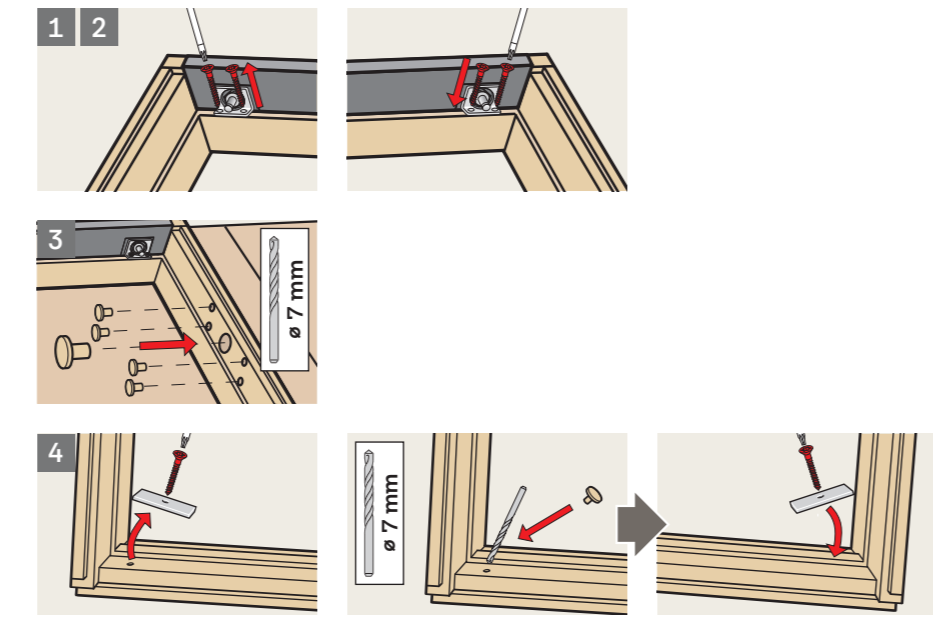

12 VELUX®

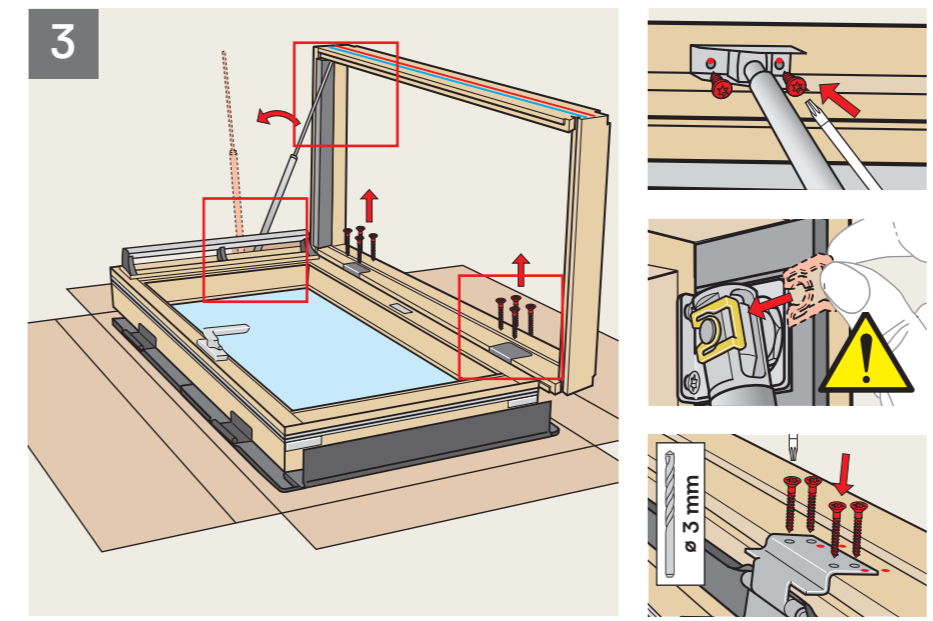
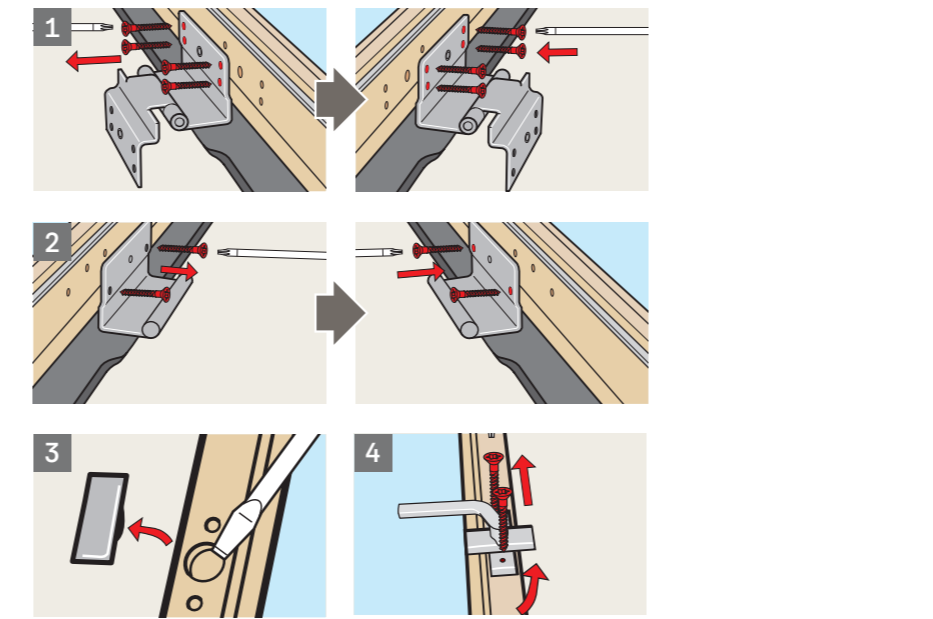

13 VELUX®

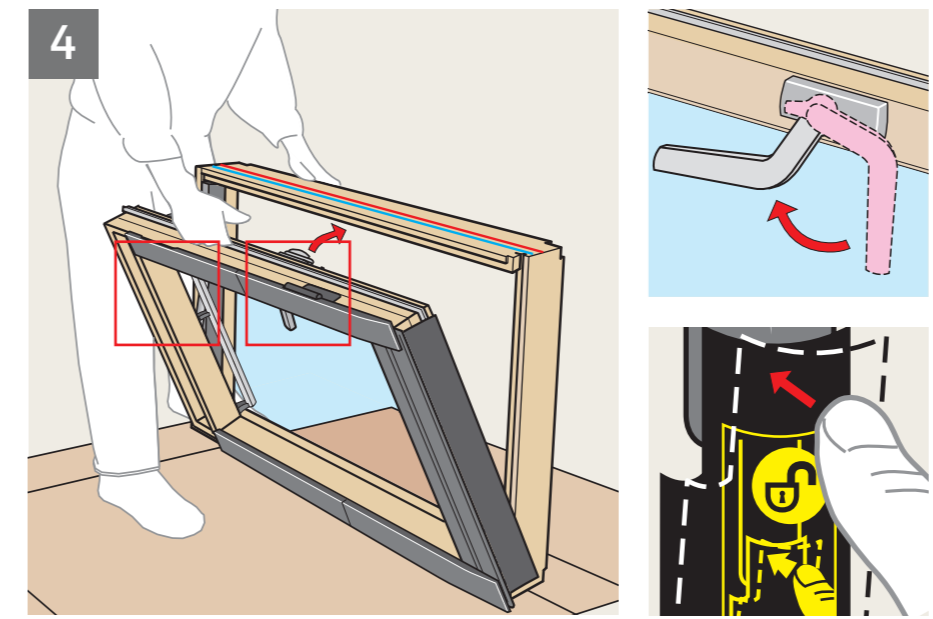

GXL/GXU

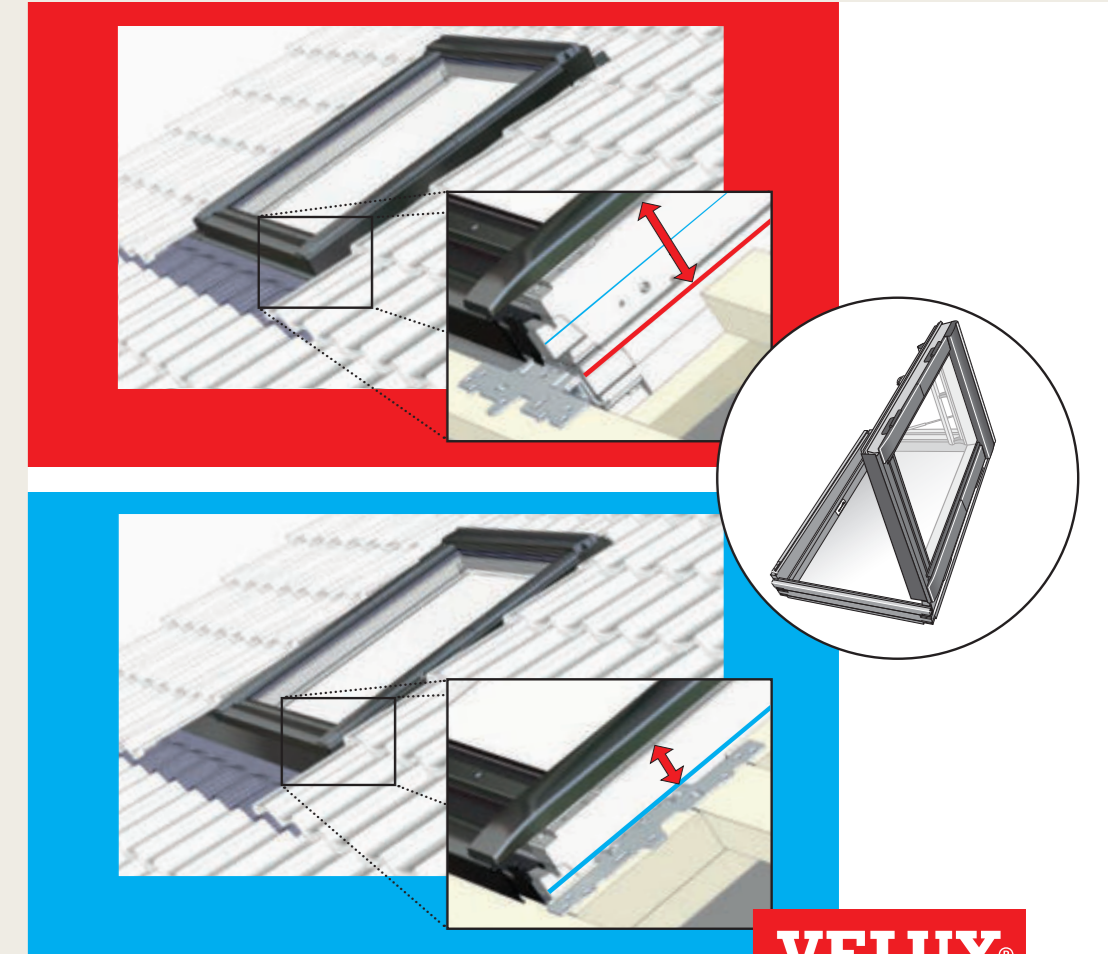

www.velux.com

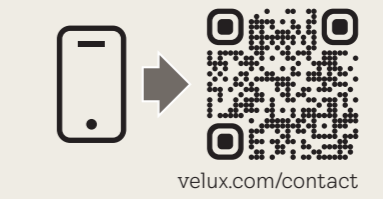

velux.com/contact

INSTALLATION INSTRUCTIONS FOR GXL/GXU ©2012-2023 VELUX GROUP. VELUX AND THE VELUX LOGO ARE REGISTERED TRADEMARKS USED UNDER LICENSE BY THE VELUX GROUP.



VAS 465314-2025-10